

DNA TRANSFORMATION OF BACTERIA – AMPICILLIN RESISTANCE

Revised 3/2003

Prepared by the Office of Biotechnology, Iowa State University

TEACHER PREPARATION AND INSTRUCTION GUIDE

Preparation for the DNA transformation experiment should begin at least 24 hours in advance of the laboratory period.

The following supplies can be provided to the class in groups of three students:

- * 2 microcentrifuge tubes (1.5 ml) containing 2 drops of sterile CaCl₂ and labeled "CaCl₂". The tubes can be put in the same ice container used to provide the DNA to the group of three students.
- * 1 aluminum foil packet containing 4 sterile toothpicks
- * 4 sterile plastic pipettes from the Office of Biotechnology
- * 1 aluminum foil packet containing 4 sterile paper clips that are large and smooth. The clips should be opened into a 90° angle and the small end bent to close it.
- * 1 Sharpie marking pen
- * 1 glass test tube with a cap (provided by the Office of Biotechnology) containing 2 ml of sterile nutrient broth and labeled "Broth"
- * 2 petri dishes containing only nutrient agar and labeled "No Amp" on the bottom
- * 2 petri dishes containing nutrient agar and the antibiotic ampicillin. The dishes should be labeled "Amp" on the bottom. (Petri dishes provided by the Office of Biotechnology)
- * 2 copies of the laboratory instructions, one for each student

The following supplies can be shared by three students:

- * 1 petri dish containing colonies of *E. coli* (MM294)
- * 1 microcentrifuge tube (1.5 ml), labeled "P", containing 4 drops of plasmid DNA that is placed on ice to keep cold until used. The tube should be labeled "DNA".
- * 1 container for used toothpicks

The teacher should have available for the entire class:

- * 1 incubator for the petri dishes set at 37° C or less. It is difficult to maintain the temperature precisely unless a research incubator is used. Prolonged temperatures above 40° C will kill the bacteria. Temperatures lower than 37° C will result in slower growth of the bacteria, but will not kill them.
- * 1 Sharpie marking pen
- * Containers for placing tubes on ice after DNA has been added, such as a styrofoam cup.
- * Containers for the 42° C water bath, such as a styrofoam cup.

STERILIZATION OF SUPPLIES

1. Sterilization of packets of toothpicks, and paper clips can be accomplished by wrapping each item in aluminum foil, labeling the contents with a marking pen, and
 - (a) baking them in an oven at 350 F for 15 minutes
 - (b) putting them in a pressure cooker at 15 pounds for 15 minutes
 - (c) placing them in an autoclave for 15 minutes.

The pressure cooker and autoclave should be at the desired pressure for the 15-minute period. After the packets have cooled, they should be stored unopened at room temperature. The students should be instructed when opening the packets to touch only that part of the object that will not come in contact with the solutions or petri dishes.

DNA TRANSFORMATION OF BACTERIA – AMPICILLIN RESISTANCE

PAGE 2

2. Sterilization of the 1.5 ml microcentrifuge tubes can be accomplished by wrapping in aluminum foil all of them needed by the teacher to prepare the supplies for the students. The tubes can be:
 - (a) baked at 250° F (they melt at 350° F) for 30 minutes
 - (b) put in a pressure cooker at 15 pounds for 15 minutes
 - (c) placed in an autoclave for 15 minutes.

3. Calcium chloride. Dissolve 0.75 g of CaCl₂ into 50 ml of distilled water in a labeled 100-ml glass bottle with a cap. Keep the cap loose and place it in:
 - (a) boiling water for 30 minutes
 - (b) a pressure cooker at 15 pounds for 15 minutes
 - (c) an autoclave for 15 minutes.Allow the bottle to cool until it is comfortable to hold, cap it tightly, and store in a refrigerator until used.

4. Ampicillin solution. For each 1,000 ml of Amp agar to be prepared, dissolve 50 mg of ampicillin (sodium salt) in 1 ml of cool sterile distilled water. The water can be sterilized by placing it in a glass bottle that is not more than half full, putting the cap on loosely, and using one of the procedures described for the calcium chloride. The sterile water should be stored in the refrigerator until it is used to make the ampicillin solution. The ampicillin solution should not be prepared and stored in advance for an extended period. The solution should be prepared and put in the refrigerator immediately before the nutrient broth solution (Item 6) and the agar plate solution (Item 7) are prepared.

5. Plasmid DNA solution. The plasmid DNA used in the laboratory has a gene for ampicillin resistance. The plasma DNA is obtained from the supplier in a concentrated solution, which has to be diluted to 0.005 ug/ul for the DNA transformation experiment. The DNA should be distributed to the students in tubes kept on ice. Any unused 0.005 ug/ul DNA can be stored in the freezer for future use. In a self-defrosting freezer, the DNA should be put on ice in an insulated container, such as a Thermos jar.

6. Nutrient broth solution. Calculate the amount of nutrient broth that is to be supplied to the students and add extra for spillage and other factors. Weigh 25 mg of LB premix /ml of distilled water into a bottle and label it. Add the appropriate volume of distilled water to the bottle. The bottle should not be more than half full so that it does not boil over during sterilization. With the cap of the bottle loose, use one of the sterilization procedures described for the calcium chloride (Item 3). After the LB has cooled and is comfortable to hold, cap it tight and store in a refrigerator until it is dispensed to the class.

Before the class, put 2 ml of the LB into glass test tubes, leave the caps loose, and place them in an appropriate rack in boiling water for 30 minutes to sterilize them. After the 30 minute-period, remove the tube rack from the boiling water, let the tubes cool, then tighten the cap. Unused broth can be reboiled and stored in the refrigerator for future use.

DNA TRANSFORMATION OF BACTERIA – AMPICILLIN RESISTANCE
PAGE 3

7. Agar plates. Two types of agar plates should be prepared: Without ampicillin "No Amp", and with ampicillin "Amp". Prepare separate solutions for the "No Amp" and the "Amp" plates. For each type of plate, 25 ml of agar solution will be required per plate. Label the plates on the underside, not the lid, before they are poured.

"No Amp" plates: Prepare 3 "No Amp" plates for each group of 3 students; one for preparation of the starter culture and 2 for each pair of students to use for transformation. It is best to prepare about 5 extra plates for the entire class in case contamination occurs in one or more of them. Place the required volume of distilled water in one or more glass bottles with caps. The bottles should not be more than half full. Add 25 mg of LB premix and 15 mg of agar /ml of distilled water. With the caps loose, sterilize the solution by one of the methods described for the calcium chloride (Item 3). After sterilization, the bottles should be swirled to mix the solution and cooled at room temperature to 55° C, which is when the bottles can be held without an insulated glove. The petri dishes labeled "No Amp" should be poured immediately. The bottom of the dish should be covered with the agar. Agar begins to solidify at about 45° C, therefore, it is important to pour the plates as rapidly as possible. If the "No Amp" agar does solidify, it can be reboiled and used again. Rinse the bottle with a large amount of tap water immediately after use so that the agar does not solidify in it or in the sink.

"Amp" plates: Prepare 2 "Amp" plates for each group of 3 students. Follow the same procedure as for the "No Amp" plates until the agar has cooled to 55° C. Add 1 ml of the ampicillin solution (Item 4) per liter (1,000 ml) of solution, swirl to mix, and pour immediately the plates labeled "Amp". If the agar solidifies, it cannot be reheated because the ampicillin will be destroyed above 60° C.

Allow the "No Amp" and "Amp" plates to harden for about 30 minutes or until the agar has a milky or opaque appearance, then turn the dishes upside down (lid down, agar up). If they are to be kept for more than 2 days, store them upside down in a refrigerator. The plates can be kept refrigerated for a month.

Note: People differ in their sensitivity to temperature and a teacher may prefer to measure the temperature of the agar to determine when 55° C is reached, particularly for the solution to which ampicillin is added. It is not possible to put a thermometer into the heated agar solution because it will become contaminated. There are two alternatives that can be used.

(A) The bottle of agar can be put into a container with the same volume of cool tap water as the volume of the medium inside the bottle. When the temperature of the tap water reaches 55° C, the contents inside the bottle should be at a similar temperature.

(B) The bottle of agar can be put into a hot water bath at 55° C and allowed to stand for 30 minutes.

DNA TRANSFORMATION OF BACTERIA – AMPICILLIN RESISTANCE
PAGE 4

PREPARATION OF THE *E. COLI* STARTER PLATE

One petri dish containing live *E. coli* is needed for each group of four students. A strain of *E. coli* should be used that does not have resistance to ampicillin.

Use a sterilized transfer loop, a paper clip bent into a loop and sterilized, or a sterilized toothpick. Use the device to touch a colony of bacteria from a petri dish or test tube. Spread the bacteria on the plate in a zig-zag pattern to obtain individual colonies as the concentration of bacteria on the transfer device becomes less. Incubate the plates at 37° C for 24-36 hours. Colonies should grow to the size of this 0 for use in the lab procedure.

CLEAN UP AFTER THE LABORATORY

Sterilize used toothpicks and 1.5 ml microcentrifuge tubes before placing them in the regular trash. Sterilize the pipettes before washing them. Sterilization can be achieved by placing them in boiling water for 30 minutes, autoclaving for 15 minutes, or putting them in a pressure cooker at 15 pounds for 15 minutes.

Wash glass bottles, pipettes, and paper clips for future use.

Petri dishes can be burned, if convenient. If not, freeze the plates overnight or allow them to dry out in the refrigerator for 1 month, then wrap them securely in a plastic bag and place them in the regular trash.

DNA TRANSFORMATION – AMPICILLIN RESISTANCE

STUDENT INSTRUCTIONS

Genes control the traits that living organisms possess. Bacteria, such as *E. coli*, have genes on their chromosome and on a small circular piece of DNA called a plasmid. Genes can be transferred from one bacteria to another on the plasmid by a process known as transformation. In this experiment, a plasmid with a gene (DNA) for resistance to the antibiotic ampicillin will be used to transfer the resistance gene into a susceptible strain of the bacteria. The same technique is used to transfer genes (DNA) for production of insulin, growth hormones, and other proteins into bacteria. The transformed bacteria are used in fermentation to produce commercial quantities of the protein for treating diabetes, dwarfism, or other uses.

You will work with two other people in conducting this laboratory.

PreLab DAY 1

- Step 1. Use a separate sterile toothpick to transfer a colony of *E. coli* about the size of this 0 into each of two tubes of calcium chloride. Use the toothpick to stir the cells vigorously and thoroughly into the solution. The solution should appear milky. Close the caps of both tubes and discard the toothpicks into the container provided for that purpose. One person in the pair should label one of the tubes "B1". The other person should label the other tube "B2".

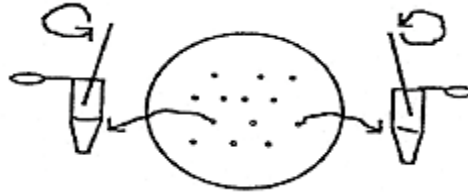

- Step 2. Place the tubes back in the ice and place the container of ice with tubes back in the refrigerator. (DO NOT FREEZE) (*The cold calcium chloride, in the tubes, conditions the surface of the bacteria for DNA uptake the following day.*)

DAY 2

- Step 1. Finger flick tube to resuspend cells.
- Step 2. Open the tube labeled "B1" and with a sterile pipette add one drop of solution from the "P" tube. Close the tube. Do not add anything to the tube labeled "B2". (*The plasmid DNA, from the "P" tube, added to the tube has a gene for resistance to ampicillin.*)

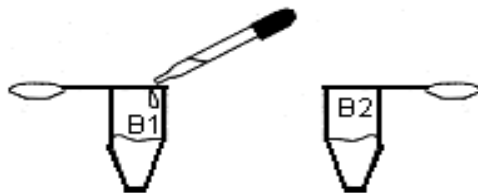

- Step 3. Place the tubes on ice for 15 minutes. (*The cells are kept cold to prevent them from growing while the plasmids are being absorbed.*)

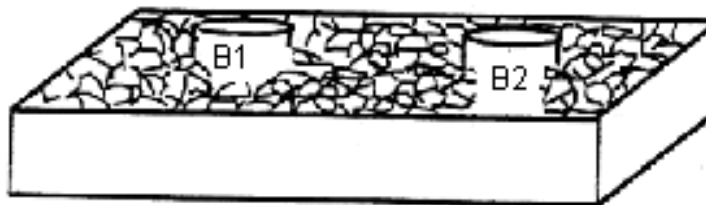

DNA TRANSFORMATION – AMPICILLIN RESISTANCE
STUDENT INSTRUCTIONS – Page 2

- Step 4 Remove the tubes from the ice and immediately hold them in a 42°C water bath for 90 seconds. (*The marked temperature change causes the cells to readily absorb the plasmid DNA*).
- Step 5. Use a sterile pipette to add 5 drops of sterile nutrient broth to each of the tubes. Close the tubes. Mix by tipping the tube and inverting it gently (*The bacteria are provided nutrients to help them recover from the calcium chloride and heatshock treatments*).

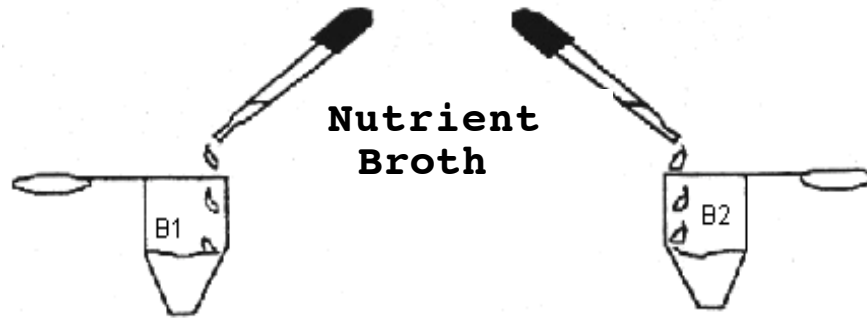

Note: For better results allow cell recovery at 37° C for any amount of extra time, 20 minutes preferred.

- Step 6. Label the underside of the four petri dishes with your name. On one "Amp" plate, print "B1" and on the other "Amp" plate print "B2". On one "No Amp" plate print "B1" and on the other "No Amp" plate print "B2".

- Step 7. Use a fresh sterile pipette to place 3 drops of cell suspension from the tube labeled "B1" onto the center of a petri dish labeled "Amp"/"B1" and 3 drops to the center of a dish labeled "No Amp"/"DNA". Use another fresh sterile pipette to place 3 drops of cell suspension from the tube labeled "B2" onto the center of the dish labeled "Amp"/"B2" and 3 drops to the center of the dish labeled "No Amp"/"B2". Use a fresh sterile paper clip to spread the liquid evenly across the surface of each plate. Do not touch the part of the paper clip that comes in contact with the agar.

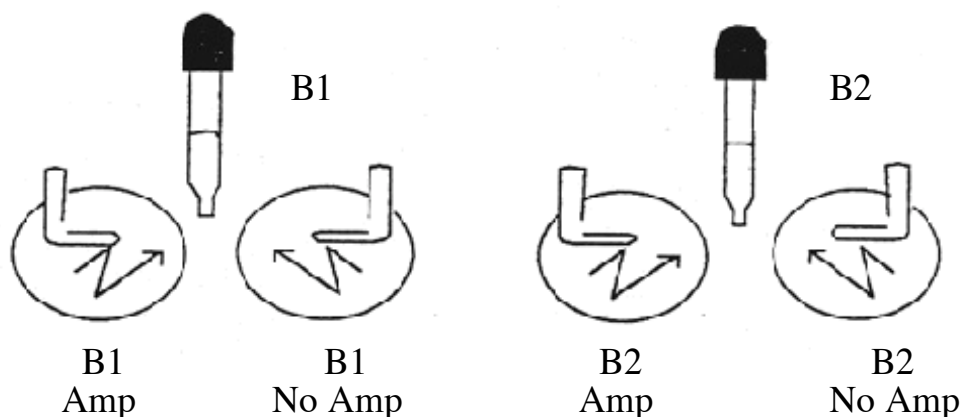

DNA TRANSFORMATION – AMPICILLIN RESISTANCE
STUDENT INSTRUCTIONS - Page 3

Step 8. Incubate the plates upside down for 24 hours at 37° C.

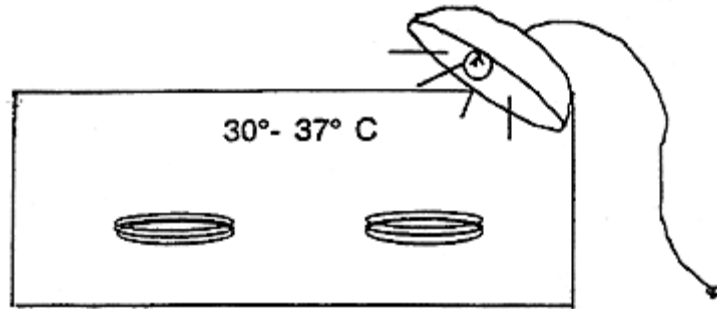

Step 9. Analyze the results of the transformation by placing the two plates labeled "Amp" and the two plates labeled "No Amp" together. *(The plate labeled "Amp"/"B2" should not have bacterial growth because the bacteria are killed because they did not have resistance to the antibiotic ampicillin. Bacterial growth on the "Amp"/"B1" plate is from cells that took up plasmids added in step 2 and that became resistant to ampicillin. There is extensive bacterial growth on both of the "No Amp" plates because the antibiotic was not present and both resistant and nonresistant bacteria could grow.)*

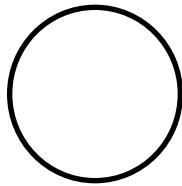

B2
Amp

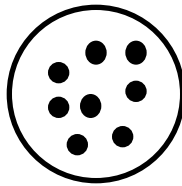

B1
Amp

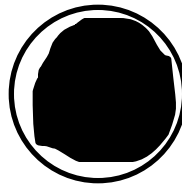

B2
No Amp

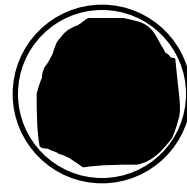

B1
No Amp